

A review of liquid phase systems pertinent to diamond synthesis

R. C. DeVries,* R. Roy,** S. Sōmiya[†] and S. Yamada[†]

*17 Van Vorst Drive, Burnt Hills, NY 12027 and **Materials Research Laboratory, The Pennsylvania State University, University Park, PA 16802

[†]The Nishi Tokyo University, Setagaya, Tokyo, Japan.

The evidence from nature and from a wide range of experiments clearly indicates several routes via liquid phases for the synthesis of diamond, graphite, and poorly crystallized carbons over a range of temperatures and pressures. This review of the literature summarizes the following separate carbon-liquid regimes which are closely related to synthesis of various forms of carbon: (1) carbon as soot, carbon black, amorphous carbon, and graphite from C-H liquids derived from petroleum; (2) carbon from molten metal solvents including those containing hydrogen—especially the ideas proposed for solution/catalysis synthesis of diamond from different precursor carbons; (3) carbon from C-H-O liquids—primarily in natural systems—as evidenced by inclusions in quartz and diamond, coated diamond, diamond/graphite from metamorphic rocks and kimberlites, and poorly crystallized carbons from sedimentary rocks; (4) carbon from ionic liquids such as carbonates, silicates, and halides—both natural and synthetic. Also considered are the possibility of connections among these categories.

INTRODUCTION

The topic of diamond synthesis has become very prominent in contemporary materials research since the mid-1980's when the work of the NIRIM laboratory^{1,2} which built upon the earlier Spitsyn and Deryaguin work³ was first appreciated. Synthetic diamonds for abrasive grain had been made since 1955 via the high pressure route developed and commercialized by the General Electric Company.⁴ The low pressure synthesis of diamond by CVD processes brought a new emphasis and interest that has produced new products, new companies and new science and engineering. The beginning point of our enquiries is the question: Are there other P-T regimes for diamond synthesis distinct from the 60 kbar/1400°C and 1 atm./950 C regimes? To that end we have assembled in this review the nature of and possible connections among some liquid phases which can produce a variety of forms of carbon. This overall perspective has a bias toward the relationship of these liquid phases to diamond formation; for example, the

nature of petroleum coke from C-H liquids and the form of carbon derived from them appears to have a bearing on the synthesis of diamond under high pressure-high temperature conditions. In addition there is a possibility of metal-C-H liquids playing a role in both low and high pressure synthesis of diamonds. This review is presented in the compositional sequence: (1) C-H; (2) metal-C; (3) metal-C-H; (4) C-H-O; (5) C-H-O-X (where X can be a number of cations). The vapor state of (1) above is the critical system in the CVD synthesis of diamond at low pressures. Finally we briefly explore possible connections between high and low pressure synthesis.

Carbon from C-H Liquids

The production of soot, carbon black, amorphous carbon, and graphite from C-H liquids is a major manufacturing entity by itself with a vast literature. The emphasis here is in the special context of understanding the

chemical, structural, and processing roles in control of the structure of the final product.

In the extensive literature on glassy carbon we find various summaries of the differences in carbons resulting from the pyrolysis of gases, liquids, and solids. Yamada has summarized these differences in tabular and graphic form (Table 1, Figure 1).^{5,6}

The key message pertinent to diamond synthesis from the vast literature on carbons from liquid precursors is the fact that both graphitizable and non-graphitizable products are formed in the processing depending on the starting material. Accompanying the microstructure is a variation in the amount of sp^3 and sp^2 bonding and in the impurities present. This becomes important in diamond-forming reactions in metal melts at HPHT conditions. As will be discussed later, it would be helpful to have a better understanding of the precursors with regard to degree of graphitization, bonding, composition, kinetics of solution, etc. The results using vitreous carbon for diamond synthesis have been controversial in part because of the uncertainties about the starting material.

Carbon from metal-C liquids

In the manufacturing process to make diamond at high pressures and high temperatures (HPHT), a carbon source reacts with a pure or alloyed metal (usually selected from among Fe, Ni, Co, Mn) to yield a liquid phase from which all HPHT diamond is precipitated.^{4,7} The carbon source is usually a graphite derived from petroleum and the form of carbon derived from hydrocarbons is dependent on the original petroleum coke and the way it was formed by nature and subsequently processed by engineers. There's considerable agreement among those that publish on the role of the carbon source in the diamond synthesis that a reasonably well-graphitized carbon is preferred.⁸⁻¹¹ Vitreous carbon, amorphous carbon, soot, peanut butter, etc. do not produce diamond of good quality or high yield without some degree of graphitization either prior to or during the

process. Diamond makers have their own source of graphite yet all make competitive products which means they learn to adjust process parameters to the carbon available.

Although we emphasize here metal-carbon melts, it is interesting to note that the direct conversion of carbon to diamond (i.e., without metal) also is dependent on the structure and degree of graphitization of the starting material.^{12,13} The model invoking rhombohedral graphite as a lower energy, intermediate step to diamond is based on this concept.^{14,15} This is much more intuitively reasonable than the paradox of why the form of the starting carbon should make any difference if it first goes into solution in a metal-carbon melt. Early on in the successful synthesis of diamond at HPHT, it was postulated¹⁶ and proved that the addition of a metal would lower the activation energy for the conversion of graphite to diamond, but the role of metal has been somewhat ambiguous. This subject cannot be amplified without first a statement about the term "solvent-catalyst" which conceals unknowns about the metal-carbon melts with respect to diamond-making.

The metal as solvent

A great deal of useful information on metal-carbon systems at HPHT has been published.¹⁷⁻¹⁹ The T-X diagram at constant P and the P-T projections for constant X are the diamond makers' maps (Figures 2 and 3). The minimum T conditions for nucleation of diamond are clearly a function of the temperature of the diamond-metal eutectics as a function of pressure.¹⁷ The formation of carbides and the necessary modifications of the phase diagrams are well established for the Fe-C, Ni-C, Co-C, and Mn-C (with alloying elements). Progress in the design and understanding of alloy carbon systems has clearly been dependent upon the phase-equilibria/solution model. The solution concept is invoked to explain the driving force for the rapid supersaturation of the liquid with respect to diamond when starting with the less stable graphite in the diamond-stable region

Table 1. Three main routes to carbon from organic materials.

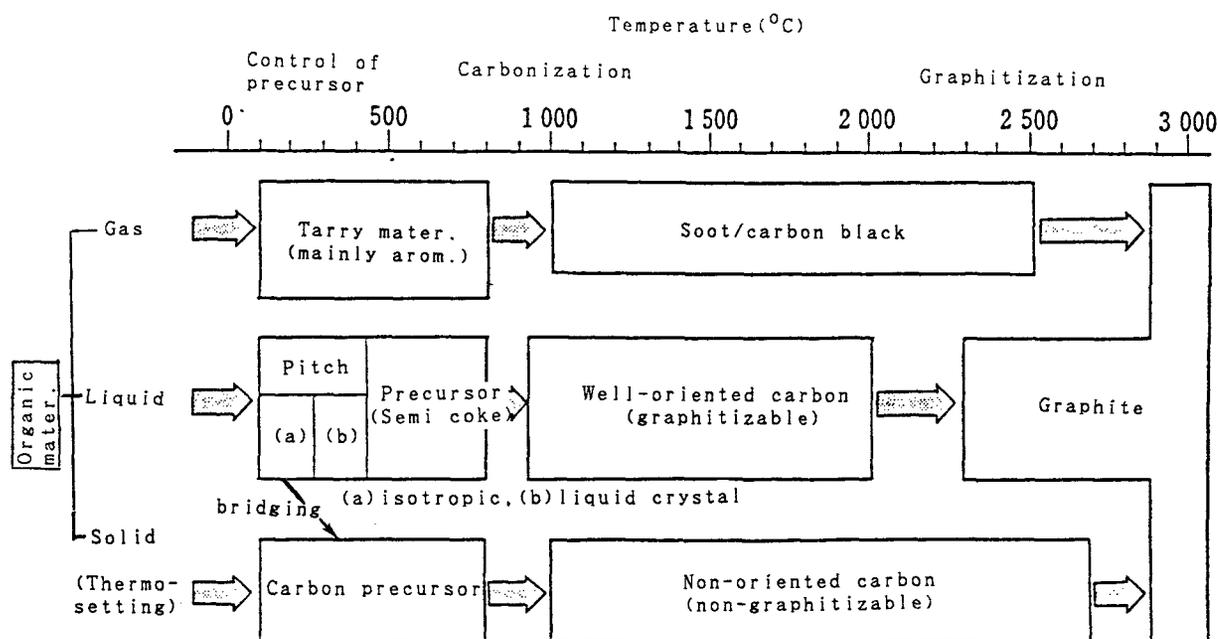

(see Figure 2). The metastable extension of the graphite solubility curve into the diamond plus liquid region graphically shows the greater solubility of graphite compared to diamond and the basis for rapid nucleation. Also consistent with a solution model is the growth of the diamond via a layer (thick or thin) of metal melt serving as a transport medium for carbon from the source carbon onto the diamond surface.

The form of the carbon in the melt has been the subject of much speculation: atoms,^{11,20,21} charged ions,²⁰ intermediate compounds and metastable excited complexes,^{22,23} colloidal clusters,^{11,24,25} planar graphite fragments,^{21,26-28} carbides,²⁹⁻³² etc. Some of these clearly bear some relationship to the original carbon at the least in terms of wetting and reactivity, kinetics of reaction (graphite edges are more reactive than the planes, e.g.). Graphite is found as inclusions in the diamonds grown relatively quickly for abrasive grain. However in the growth of gem quality crystals

under more nearly equilibrium conditions with the melt, graphite inclusions are relatively rare. This suggests that clusters and fragments, if they exist, must be rejected or broken down at the growing crystal surface if sufficient time is available. Diamond clearly grows in most HPHT systems as the stable phase precipitating from a supersaturated carbon-metal liquid.

There have been studies comparing amorphous or vitreous carbons with well-crystallized graphites with respect to diamond-making.^{10,26,33-35} The former, with a lower stability than graphite, tend to go into solution faster; but in spite of what should lead to even more rapid supersaturation, fewer nuclei are formed.³³ It is difficult to sort out the causes of some of these effects because amorphous carbon materials tend to be harder and less deformable.³⁶ Thus, for example, the pressure might not be as high as expected, and nucleation is very directly dependent upon pressure. Vitreous materials may also contain

impurities that could influence melting temperature and diamond stability; this will come up again in the discussion below of metal-carbon-hydrogen systems.

The metal as a catalyst

In the early years of HPHT diamond synthesis, an extensive debate occurred between two schools of thought: one contending as above that diamond formation was a simple equilibrium process of precipitation from a

saturated liquid; the other, that the molten metal acted as a "catalyst." Support for catalysis is based on the fact that some metals such as Pb, Sb, Zn, Cu dissolve C to the same extent as diamond-forming metals but do not produce diamond under typical HPHT conditions.³⁷⁻³⁹ Perhaps this should be modified to "not produce diamond as easily," because more recently it has been shown that if high enough pressure is used (above 70 kB), diamond forms from a variety of systems.⁴⁰⁻⁴² Cu-C is a

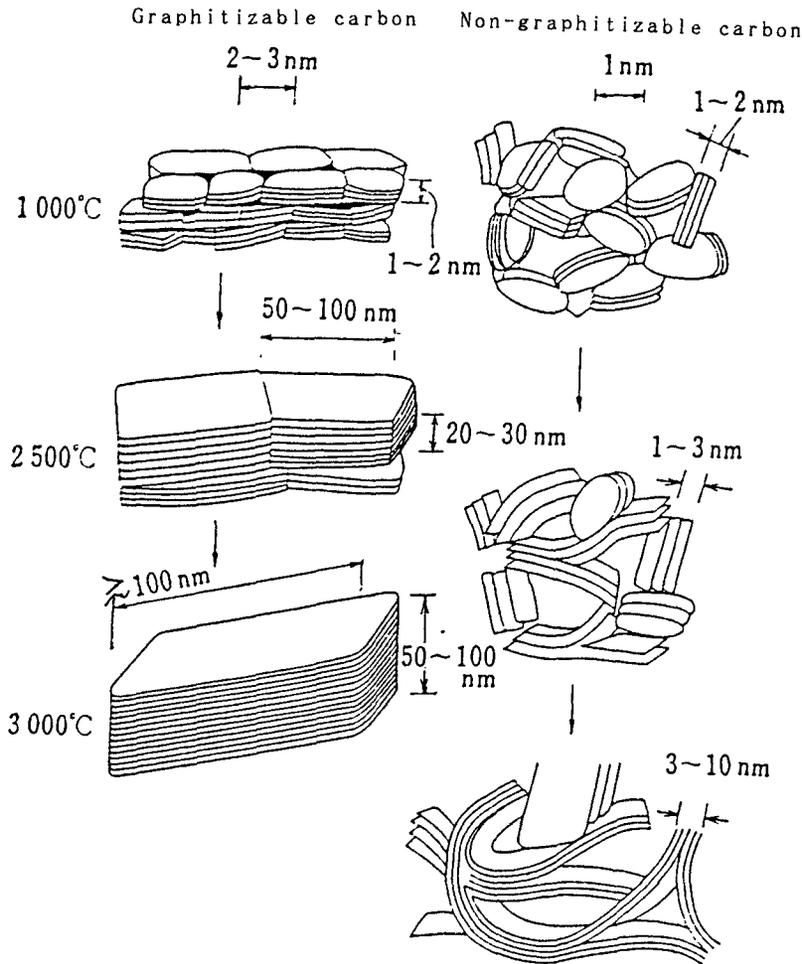

Figure 1. Crystallostructural change at the graphitization process.

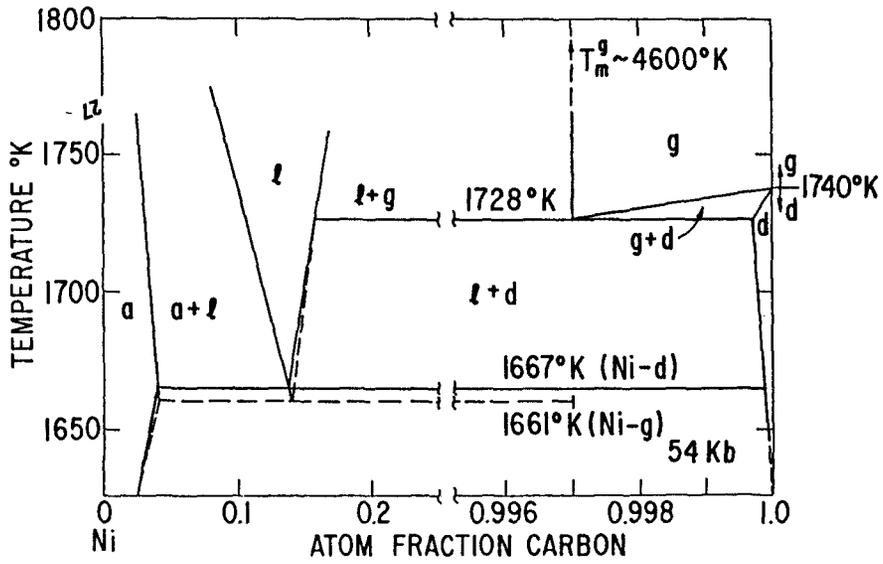

Figure 2a

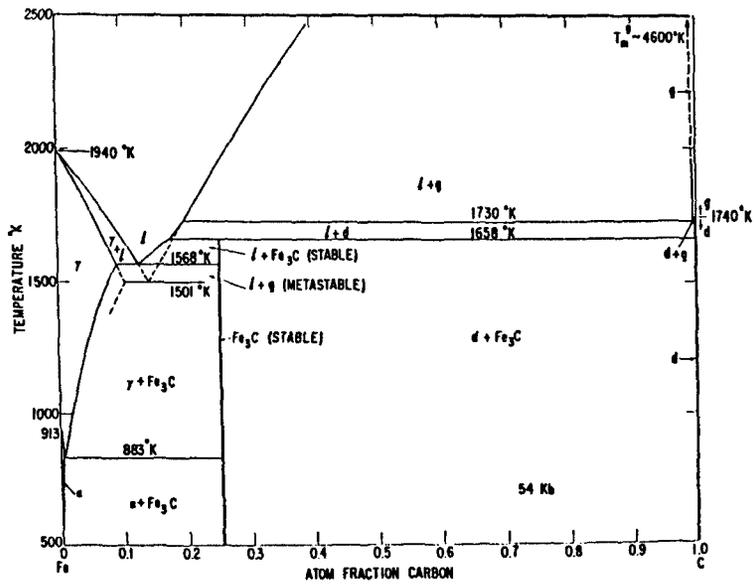

Figure 2b

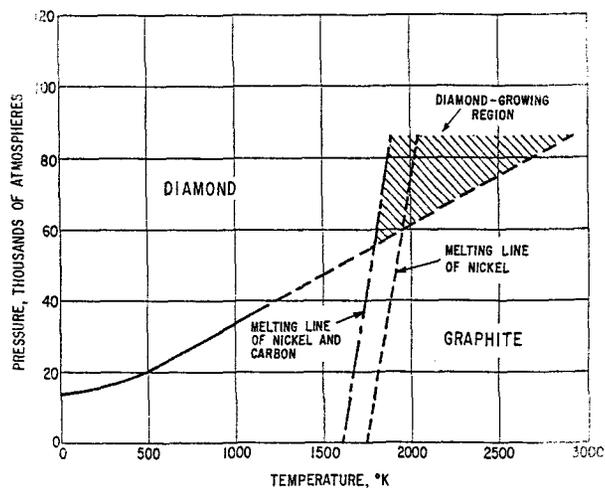

Figure 3.

example of a non-diamond forming system that is dramatically altered by the addition of 1 wt/% Ni, which then seems to be acting as a catalyst.^{38,39} Related is the demonstration that by alloying Cu with Nb an equivalence to Ni is achieved via the role of Nb as an electron acceptor and Cu as an electron donor.⁴³ Diamonds are grown in such an alloy when carbon is added.

Consistent with catalysis is the model in which it is proposed that divalent metals intercalate graphite to produce puckering of the structure to favor a martensitic transformation of graphite to diamond without alteration of the metal.^{7,21,27,44} In this model non-graphitized carbons would have to first be graphitized in situ in the melt. The direct conversion process (without metal) has also been described as a diffusionless martensitic transformation.⁴⁵

Metal-C eutectics and diamond synthesis

Whatever the mechanism, there is a direct relationship between the initiation of nucleation and the temperature of the Me-C eutectic in the HPHT processes for diamond synthesis. Figure 3 is a summary of projections onto a P-T plot of Me-C eutectics (from binary systems at constant pressure). These lines define the initial temperature of formation of diamond

for each system. The range is obviously rather large and seemingly only a function of finding suitable Me-C systems. What are the lower P-T limits that can be attained? In spite of the lowering of temperature for initiation of nucleation and reports of lower pressure minima as well for cubic BN^{46,47} and diamond (see below), there seems to be a lower *practical* pressure limit for current products at 40 to 45 kbar. (Curiously this appears to be true for natural diamond as well.) This raises some questions about kinetics, nature's laboratory.

Summary

The term "solvent-catalyst" means that there is indeed solution and transport of carbon through a liquid phase, but in the absence of carbide formation (i.e., alteration of the "catalyst" metal) there seems to be support to invoke some catalytic character as well. There are many ideas about the nature of carbon in these liquids, but tons of diamond abrasive grain are available without the luxury of understanding. It is obvious that the first appearance of diamond in HPHT processes is directly related to the temperature of the metal-carbon eutectic as a function of pressure and that may be controlled by alloying.

Carbon from Metal-Carbon-Hydrogen Liquids

Hydrogen and vitreous carbon

Recent reports of formation of diamond below 40 kbar using conventional Fe, Ni, Co alloys⁴⁸⁻⁵⁰ have aroused curiosity about how this can be especially since this surprising, and apparently reproducible,⁵¹ result was achieved using a partially hydrolyzed phenol formaldehyde resin. The carbonized substance (vitreous carbon) has sp^3 bonding and free radicals. Originally reported in 1987,⁴⁸ it was proposed that hydrocarbon might be a source for diamond formation at lower P and T in the earth. (This is not a new idea as will be shown below in the section where the evidence from nature is evaluated, but the realization has been elusive.) The experiment appears to have been reproduced with a synthesis at about 31 kbar

from the same starting material.⁵¹ Since 31 kbar approaches about half the normal practical pressure, it would be of very practical interest to better understand the phenomenon. In a follow-up patent, Niedbalska reports seeded growth as low as 20 kbar and 1100°C (well below the Berman-Simon line), but the alloying is now more extensive with the addition of lower melting elements.⁵⁰ This eutectic is shown in Figure 4. The minimum temperature (1100°C) may be reasonable, but one should be skeptical of the claim of 20 kbar according to another study on a variety of hydrocarbon starting materials where no synthesis below 40 kb was found.⁵² In this study it was postulated that the 4.85% of hydrogen present acted as an additional catalyst (or solvent?).

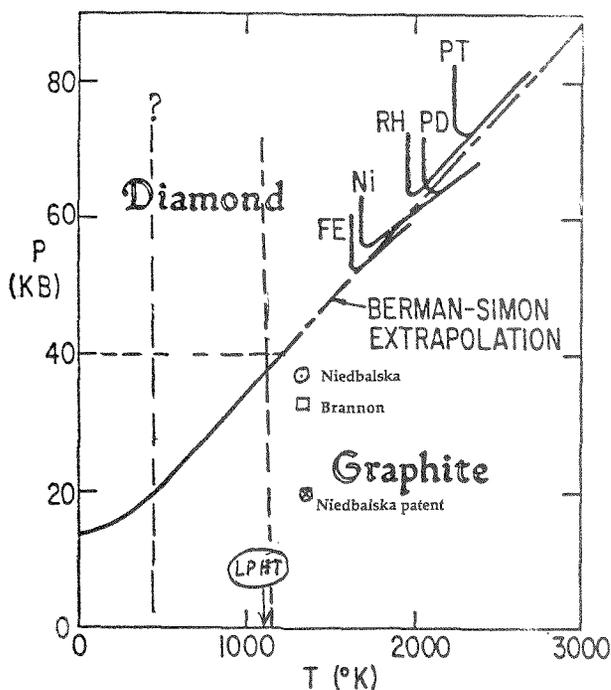

Figure 4.

The general prior experience with using vitreous carbon (which can contain some hydrogen) and the deliberate addition of hydrocarbons or water to the normal solvent-

catalyst method has not been very encouraging. Hydrogen has long been considered to be a very deleterious addition in terms suppression of diamond nucleation and other problems.⁵³⁻⁵⁶ The deliberate addition of H₂ or H₂O precludes diamond formation in the Me-C systems in the usual pressure range although synthesis from LIH-graphite is reported.⁵⁷ In fact it requires very high pressures (> 70 kbar) for diamond to form from a graphite-water system.⁴² Recent quantitative studies investigating the role of hydrogen report 2200 ppm H₂ as the maximum amount allowable.⁵³ As mentioned earlier the results with vitreous carbon seem to agree on less nucleation in spite of faster supersaturation of the metal with carbon; but it is not clear if this is a chemical or mechanical effect or both.

We suggest that, in spite of the lack of agreement, there is a strong possibility that the addition of hydrogen can lower the Me-C eutectic melting at high pressures. There is certainly ample evidence from the reactions of diamond or graphite with metal and hydrogen at one atmosphere and below in the form of gasification of graphite,⁵⁸ the VLS growth of graphite in the temperature range of 1000°C,^{59,60} (see Fig. 5) and the recent results from CVD deposition of diamond which are described below to indicate that the behavior in the HPHT systems may be related to the availability and form and kinetics of reaction of the hydrogen with the other elements.

The LPSSS process

In 1992 Roy et al.^{61,62} reported on a new low pressure solid state source process in which diamonds were grown below 1 atm. with starting materials very similar to those used in the HPHT process. These consisted of graphite (or other carbon source) mixed with several percent of metal (Ni, Cu, Mo, etc.) or a few percent of 1-10 micron diamond structures. The latter process is not described further here; for details see Ref. 42. Such starting materials are heated to temperatures in the range of 800°-1200°C in an atmosphere containing atomic hydrogen. The solid state carbon source is converted to diamond. In this work there is clear evidence for the

formation of Me-C-H liquids in the form of metal droplets from a few microns (to nearly millimeters) at temperatures (<1000°C) far below the metal-carbon eutectics.

Badzian and Badzian⁶³ described an experiment of inserting a Ni metal foil 1 mm above a HOPG graphite substrate in a microwave H₂ plasma. Ni is evaporated onto the HOPG. The Ni foil is removed and methane admitted at 925°C in a microwave plasma. The resulting products show clear evidence, of "liquid-like" microstructures of nickel only, and with only diamond. Roy et al.⁶⁴ in the metal seeded graphite LPSSS work show very similar evidence for "liquid" phases at 985° in the system Ni-C-H-H₂ system and the analogous Cu system. All samples show the conversion to diamond with metal spheres or "snakes" nearby. The role that these metal-rich liquids play in

the formation of diamond is unclear. While they always appear along with the diamond in the LPSSS process, there is no direct evidence that the diamond actually crystallizes out of the liquid (the diamond crystals are not clustered around the metal spheres or tubes). One has to invoke possible small particles of a crystalline Me-C-H or metastable Me-H phase as a crystallographic substrate for diamond. One also has to appeal to Me-C-H ternary eutectics as Yang et al.⁶⁵ have done. Insufficient work has been done to decide whether these are stable ternary eutectic liquids of hydrogen-metal-carbon or of metastable liquids of *atomic* hydrogen-metal-carbon. Indeed the matter of solubility of atomic hydrogen, a different thermodynamic entity distinct from H₂, will have to be addressed.

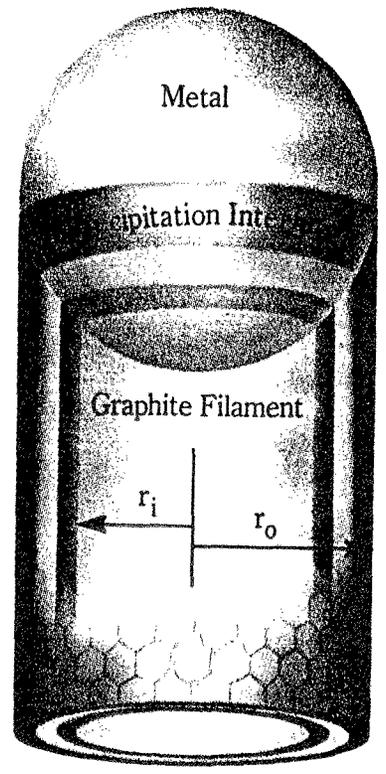
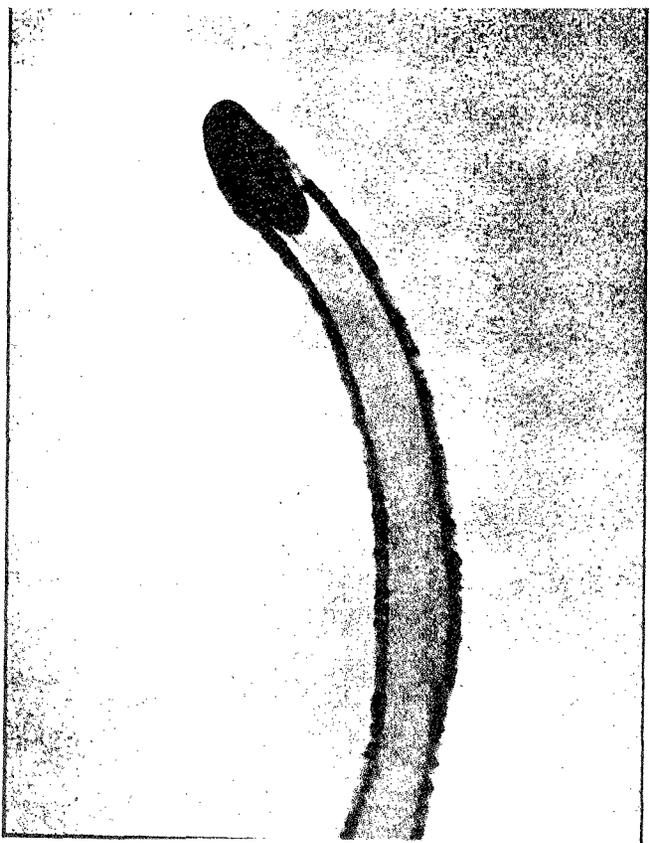

Figure 5.

Summary

Hydrogen (molecular and atomic) is one of the principal "alloying" elements that can lower eutectic melting temperatures, but variability in mode of introduction and amount available for reaction may account for the lack of agreement among different HPHT experiments. The evidence from low pressure studies is much more supportive of lowering of melting by hydrogen in metal-carbon systems—both for graphite formation and recently for diamond synthesis.

Carbon from C-H-O Liquids

Theoretical calculations

There were visionaries who appreciated the concept of hydrothermal carbon and did thermodynamical calculations of equilibrium reactions leading to both diamond and graphite.⁶⁶⁻⁶⁸ One predicted minimum set of conditions for diamond formation from such calculations was 20 kBar and 1000°C⁶⁸ (i.e., below the Berman-Simon line⁶⁹ (see Fig. 4). Others speculated that compositions in the C-H-O system are the carbon source for diamond and graphite formation.⁷⁰⁻⁷⁴ Recently the sp^3/sp^2 ratios under various p-t conditions from 700 to 1300 K and 5 to 10 kbars in the C-H-O system in the hydrothermal regime were calculated by Piekarczyk⁵⁰ and are included as Appendix 1. The data are shown in Table 2. The results predict that at temperatures in the lower end of the hydrothermal range and pressures in the higher end the sp^3 diamond configuration is favored by a 10^4 - 10^6 ratio. Hence slow diamond growth should be possible.

Evidence from natural systems

From graphite, diamond and petroleum occurrences in nature, there is no argument about the presence of C-H and C-H-O gases liquids in rocks. Petroleum (and petroleum cokes) as precursors to synthetic carbons, including graphite, has been considered in a previous section. Here we concentrate primarily on the evidence for C-H-O liquids in nature as sources for poorly crystallized carbons, graphite and

diamond. We believe there is no question about this, and there is considerable, recent awareness and support for such C-H-O liquids and solids coexisting with oxides in nature.⁷⁶⁻⁷⁸ Defining the details of the exact species under conditions (P,T, fO_2) in the earth is an active area of research.⁷⁹⁻⁸³

Inclusions in quartz

The precipitation of carbon from C-H-O systems (CO_2 - CH_4 - H_2O -...) is clearly documented in an extensive literature which because of space restrictions cannot be adequately treated here. We start with an example which immediately convinces any observer with no equipment other than a naked-eye: the occurrence of poorly crystallized natural carbons such as anthraxolite and shungite which clearly formed under mild hydrothermal conditions where quartz is usually formed. For the famous Herkimer and Marmaros "diamonds" (quartz crystals), the formation of single crystal quartz and the high carbon phase was clearly simultaneous—there being many samples of each being included in the other.^{84,85} The hydrothermal conditions were probably in the range of 300°-500°C and about 1 kBar. We suggest that if the pressure had been greater than (no more than about 40 kBar), some of the carbon could have been converted to diamond.

Likewise, liquid and gaseous *hydrocarbon* inclusions in quartz and carbonates provide indisputable evidence of coexistence in apparent equilibrium of these very unlike and chemically immiscible phases. Analyses of liquid inclusions in quartz crystals shows compositions in the C-H-O system (Table 3).⁸⁵ A very pertinent, if accidental, experiment visually demonstrated the precipitation of carbon when a gas inclusion was heated by the laser beam.⁸⁶

Graphite deposits

Natural graphite occurrences and their origin have been studied extensively, and the evidence for the role of liquids in the C-H-O system is conclusive.⁸⁷⁻⁹² The composition of liquids in equilibrium with graphite are shown

in Figure 6.⁹² (This figure will be considered again along with the C-H-O diagram for CVD diamond synthesis when discussing the concept of a continuum between high and low pressure synthesis of diamond.) The rather mild hydrothermal conditions for obtaining a high degree of graphitization in nature compared to the high temperatures for commercial processes suggest that to offset the infinite time of nature's laboratories, there may also be some kinetic advantages in hydrothermal systems.

Inclusions in diamonds

In pioneering studies many years ago, natural diamonds were cracked in a mass spectrometer, and the emitted gases were analyzed.⁹³⁻⁹⁶ It was clear that several species from the system C-H-O were present. Because natural diamonds also contain other minerals as inclusions, it's possible some of these species could have come from nondiamond material. However the simultaneous genesis of both diamond and nondiamond phases is compatible

Table 2. The ratio of the number of sp^3 bonds to the number of sp^2 bonds as a function of temperature, T, and equilibrium partial pressure of atomic hydrogen, P(H).

T	P = 5000 atm		P = 10000 atm	
	P(H)	$n(sp^3)/n(sp^2)$	P(H)	$n(sp^3)/n(sp^2)$
700	.85436E-13	3.05E+09	.10163E-12	8.63E+09
800	.15762E-10	9.26E+06	.18760E-10	2.63E+07
900	.92442E-09	1.06E+05	.11012E-08	3.03E+05
1000	.24221E-07	3.08E+03	.28895E-07	8.88E+03
1100	.35218E-06	1.76E+02	.42104E-06	5.11E+02
1200	.32847E-05	1.82E+01	.39386E-05	5.01E+01
1300	.21727E-04	4.18E+00	.36153E-04	8.64E+00

Table 3. Composition of gases contained in the inclusions of "Marmaros diamonds" (vol. %, H₂O being not taken into account). [L. Karwowski and J. Dorda, *Mineralogia Polonica* 17:3 (1986)].

Locality	Konina*		Pod Karczma*		Pasternik Stream			Lapsze Nizne	
	70	150	100	700	100	200	500	150	600
temp °C									
comp.									
CH ₄	100	100	83.69	10.96	73.16	85.04	36.21	37.76	21.50
C ₂ H ₆	—	—	7.66	2.93	5.47	5.46	5.12	2.08	7.52
C ₃ H ₈	—	—	—	1.27	—	—	2.17	—	1.95
C ₄ H ₁₀	—	—	5.44	0.88	3.78	6.89	2.47	—	3.91
C ₃ H ₆	—	—	—	—	—	—	1.95	—	6.11
CO ₂	—	—	3.31	83.95	2.34	2.61	16.77	3.20	32.93
H ₂	—	—	—	—	—	—	32.71	56.96	26.08
N ₂	no	no	no	no	14.34	—	1.70	no	no
Ar	no	no	no	no	0.91	—	0.90	no	no

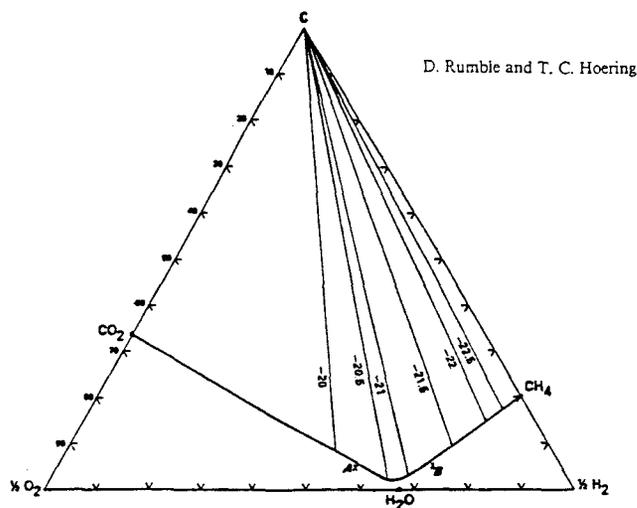

Figure 6.

with an environment containing C, H, and O. Additional support comes from optical studies of so-called coated diamonds—those that clearly had undergone a later stage of growth clearly defined from an initial core crystal.⁹⁷⁻¹⁰² Again there was evidence of species from the C-H-O systems in natural diamonds and new growth occurred on the original diamond in P-T-X environment presumably different from the core.

Diamond from kimberlite and related rocks

Most natural diamonds are found associated with kimberlite, a complex igneous rock which in some mysteriously selective way has tapped the depths of the crust to bring the diamonds nearer the surface. Current thinking based on sometimes rather vast age differences between the diamonds (older) and the kimberlite host (younger) indicate the diamonds did not originate in the host material; i.e., they are foreign minerals (xenoliths¹⁰³). This type of information is totally dependent on the analysis of non-diamond inclusions in the diamond. Graphite is also found both as inclusions and sometimes as rather large aggregates in kimberlite type rocks. The concentration of diamonds is generally small (of the order of a ppm), but individual pieces of basic rock brought

up by the kimberlite can have much higher concentrations of diamonds.

The above background on natural diamond defines some of the boundary conditions that have to be enfolded into any theory of the origin of diamonds prior to subsequent emplacement higher in the earth's crust as kimberlite pipes. The reality of C-H-O phases in diamonds (or in the accompanying non-diamond inclusions) plus the proof of similar chemistry for the genesis of graphite deposits strongly suggests C-H-O liquids as the carbon source for diamond nucleation and growth (see Fig. 7). *The chemical nature of such liquids would virtually certainly make them immiscible and non-wetting with the silicate and oxide phases present, but in equilibrium with them.* The C-H-O liquids would be a minor immiscible liquid phase, probably confined to grain boundaries regions or to small vugs.¹⁰⁴ Transport of carbon via this phase would certainly be more efficient than the diffusion of carbon-containing species through the oxide/silicate host. Simultaneous growth of both diamond and non-diamond phases, nucleation of many small crystals, and slow growth and limited size of natural

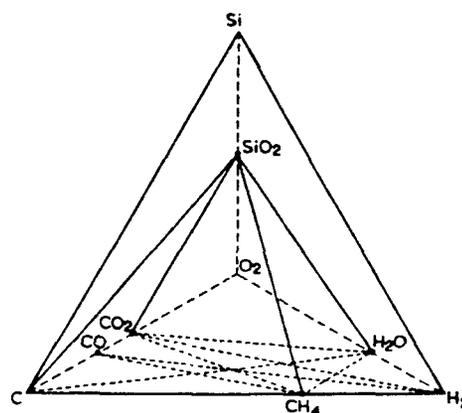

Composition tetrahedron for C-H-O reactions in the C-H-O-Si system.

Figure 7.

diamond are readily explained by this configuration and chemistry. There now are many recent papers in which authors clearly support the growth of diamond from C-H-O liquids bringing general acceptance to an old idea. The principal determinant for the formation of diamond or graphite from this chemistry is what pressure was necessary for diamond formation. The general conclusion from studies of the non-diamond inclusions and their experimentally determined stability regions is that, in nature, below about 40 kbar natural diamond generally does not form.

Diamond from metamorphic rocks

The concept of an immiscible C-H-O liquid also provides a common ground for explaining the recent discovery of diamonds in metamorphic rocks of a chemistry totally different from the basic kimberlite mode.⁵⁸ This surprising result came from careful and detailed studies by N. Sobolev and his colleagues of very small diamonds found as inclusions in minerals in metamorphic rocks in Russia.¹⁰⁵⁻¹⁰⁷ A similar find is reported from China¹⁰⁸ and in garnet-micaceous gneiss in Russia.¹⁰⁹ However the p-t conditions are thought to be above about 40 kbar and 1100 C. There is also a recent report of what seems to be overgrowth of diamond on some diamonds in a kimberlite pipe.¹¹⁰ This would be a truly amazing discovery if it holds up to further scrutiny since it would be necessary to modify somewhat the belief that diamonds are always xenoliths in the basic rocks.

Summary

There is universal agreement C-H-O liquids exist at depth in the earth. They are immiscible with silicate liquids or aqueous silicate solutions (oil and water!). Such liquids provide a common chemical origin for diamond, graphite, and less-well-crystallized carbon deposits from both kimberlite and metamorphic regimes. In this model the solid phase that forms in this model is primarily dependent upon the pressure ambient, and it appears that

diamond did not form below about 40 kbar in nature.

From our viewpoint it is certainly interesting to note that there is essentially zero research utilizing the route that nature used.

Carbon in Ionic Liquids

Carbon in oxides and silicates

The solubility and transport of carbon, per se, in oxides and silicates are not well understood, but appear to be small in magnitude in both natural and synthetic systems.¹¹¹⁻¹¹⁵ Some interesting and controversial concepts with respect to mechanisms and possible species have been proposed.¹¹⁶⁻¹¹⁸ The diffusion of carbon itself through silicates does not seem to be a very productive model to follow to explain carbon deposits. On the other hand there's a wealth of reproducible information on the solubility and transport of CO₂ and H₂O in silicates in the petrological literature.¹¹⁹⁻¹²⁵ We suggest that the a C-H-O liquid much richer in carbon than the CO₂-H₂O join from the silicate melt at high pressures and temperatures is critical to diamond and graphite genesis.

The oxidation or reduction of the species in this liquid (e.g., CH₄ or CO₂, respectively) provides the mechanism for nucleation and growth of carbon as diamond or graphite depending on the P-T conditions. Both the dominant C-H-O species and the redox reactions are function of P, T, X and fO₂.^{74,78,82} With respect to X, composition, sulphur may be an important ingredient in diamond genesis. Sulphides are important inclusions in diamond, and several have suggested their role in the reduction of C-H-O liquids.^{76,126-130} Consider the interesting possibility of three immiscible liquids; silicate, C-H-O, and sulphide, participating in the formation of diamond. With regard to oxygen fugacity, there seems to be general consensus that the fO₂ range for carbon precipitation lies between the wustite-magnetite (WM) and quartz-fayalite-magnetite (QFM) buffers.^{78,82,131-133} This range may extend to the iron-wustite (IW) buffer which would help explain the confirmed discovery by

Sobolev of native iron as in inclusion in diamond.¹³⁴ Because of the rarity of native metal in diamond, there's been little support for metal-carbon solutions as the source of natural diamond as shown to us by kimberlites and lamproites. This does not preclude this possibility occurring in a natural laboratory at much greater depth where iron is predominant. Haggerty's excellent graphical summation⁷⁸ should be consulted for a more comprehensive picture of the interrelationships among these parameters (Figure 8).

The reduction of carbonates in equilibrium with graphite and conversion to diamond has been achieved under severe P-T conditions (77 kbar, 2150°C).⁴⁰ Decomposition of FeCO_3 (siderite) to graphite and magnetite was found at about 460°C and 2 kbar,¹³⁵ and a patent claims diamond formation from the same composition at 900°C and 40 kbar.¹³⁶ Also pertinent to the search for P-T limits for diamond formation is the fact that the extensive studies on $\text{CO}_2/\text{H}_2\text{O}$ solubility at pressures up to about 40 kbar have produced no diamond but graphite.¹¹⁹

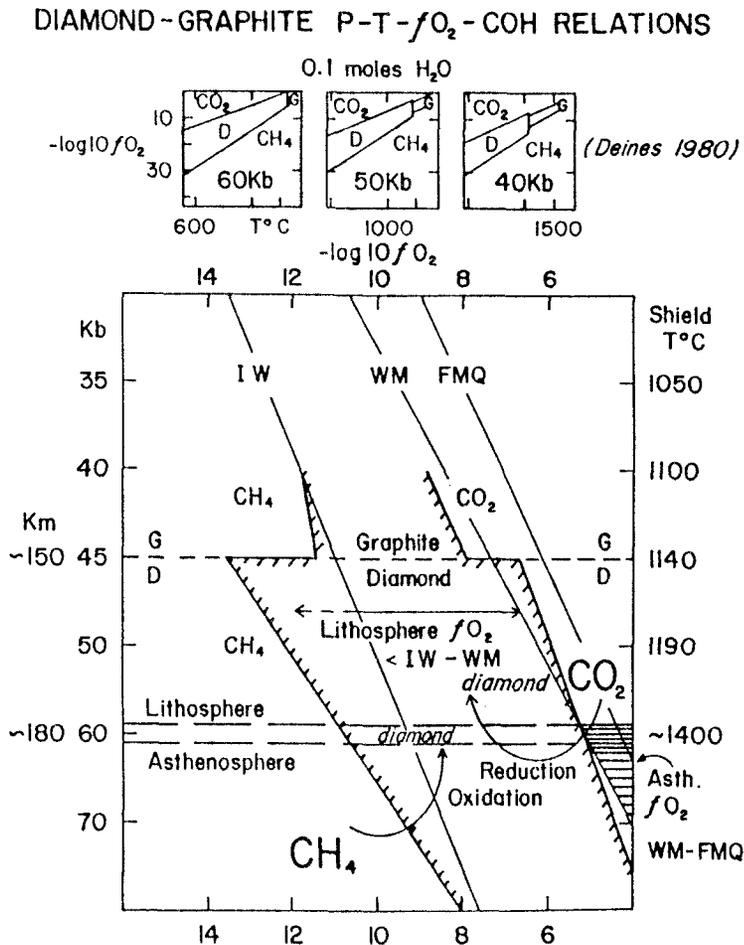
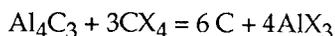

Figure 8.

Carbon in halide and nitrate liquids

Of immediate interest to diamond synthesis are two different one-atmosphere, liquid-phase processes reported by Cherian and Patel¹³⁷⁻¹⁴¹ and by French and French.¹⁴² The former were studying etching of diamond in molten salts above about 600 C in nickel crucibles and found the surprising result of hillocks or elevations in addition to etch pits. The growths were always of a faceted nature but not always of a common orientation that might be expected from growth on a diamond substrate. There appears to be a "ditch" around the hillocks. These transparent overgrowths are a few microns to 10 s of microns in size and not attacked by inorganic acids. The phenomenon has been reproduced in other laboratories, but there has been no further development, application or understanding of the process. There's speculation that an intermediate carbide phase or Ni-C complex may be involved. It's interesting to wonder about a possible analogy to the CVD diamond growth process where both diamond and graphite may form, but the latter is more rapidly removed by etching. Unfortunately the published work does not provide sufficient detail about the chemistry of the environment to define more precisely the possibilities. Perhaps this system could be controlled to fit into the metal-carbon-hydrogen category.

The work of French and French is reported only in the form of patents¹⁴² and consists basically of reactions of the following type:



where X is Cl, Br These reactions are carried out in glass flasks at one atmosphere in the presence of a molten salt (e.g., LiCl-AlCl₃) at temperatures of about 250 - 300 C. A carbon-rich, black, fine-grained powder which can scratch B₄C slightly is the product. There's no evidence from either Raman or X-ray spectra for diamond, but the hardness is certainly compatible with considerable sp³ type bonding as in diamond-like or vitreous carbons. There's no report of the effect of seeding the melt with diamond. It is claimed that diamond forms from

the reaction of polytetrafluoroethylene and Al₄C₃ at 29 kbar and 500°C.¹⁴³

Summary

Hard carbon-rich materials can be made under ambient conditions in special liquid systems, but the understanding is limited and exploitation has been essentially non-existent for some time. There's no support for synthesis of diamond below about 40 kbar. From solutions of CO₂ and H₂O in oxides and silicates.

CONNECTIONS AND CONCLUSIONS

Diamond grows from metal-carbon and from C-H-O liquids at least above about 40 kbar and 1100°C. The former is the basis for commercial production of abrasive grain, and the latter represents at least one regime of the natural environment. From the metal-carbon systems, graphite can grow metastably along with diamond from the same P-T regime and stably below the above limits. In spite of the ability to lower the initial temperature of metal-carbon eutectics and thereby the temperature of nucleation of diamond, the evidence for a significant and reproducible lowering of pressure, say to 20 kbar, from either type of liquid, is much less certain.

At the other extreme is the deposition of diamond at relatively slow rates at less than one atmosphere by chemical vapor deposition from the C-H system in the presence of atomic hydrogen with or without diamond seeding on many substrates. Under nearly similar conditions but without atomic H, graphite is formed readily in the the presence of molten metals (perhaps in a Me-C-H system). Metals have been added to the DVD diamond processes, but their role is not well-defined and certainly no diamond whiskers with a metal catalyst at tip have been found. The LPSSS process produces diamonds at less than 1 atmosphere in the presence of diamond seeds and atomic hydrogen.^{61,62,64} Instead of diamond seeds, powdered metals work. A Me-C-H melt is "involved" in the process.

Between these two extremes is there a connection that would permit synthesis of diamond at lower pressures than normal HPHT conditions and at faster rates than normal LPHT CVD? The rather substantial amount of evidence for no diamond formation in the pressure range between 1 atm and 40 kbar for both C-H-O and metal-carbon systems is not too promising in spite of the hope provided by the equilibrium line between diamond and graphite and some recent claims. Kinetics may be the controlling factor in the lower pressure range, as evidenced by the limitation of even seeding in the HPHT process in lowering both P and T.

The success of CVD diamond processes is independent of seeding (except to control nucleation) but very dependent on preventing or destroying graphite nuclei. It is interesting to compare three representations of the C-H-O composition triangle for three different P-T-X regimes. The Bachmann diagram¹⁴⁴ (Fig. 9a) summarizes the C-H-O range for CVD diamond formation from the gas phase in the presence of atomic H at about 800°C and 1 atm or less. The Jablonski diagram¹⁴⁵ (Fig. 9b) shows the stability regions at 600°C and 1 atm for metal carbide with graphite, metal, and metal oxide when Fe, Ni, Co are added to the C-H-O system

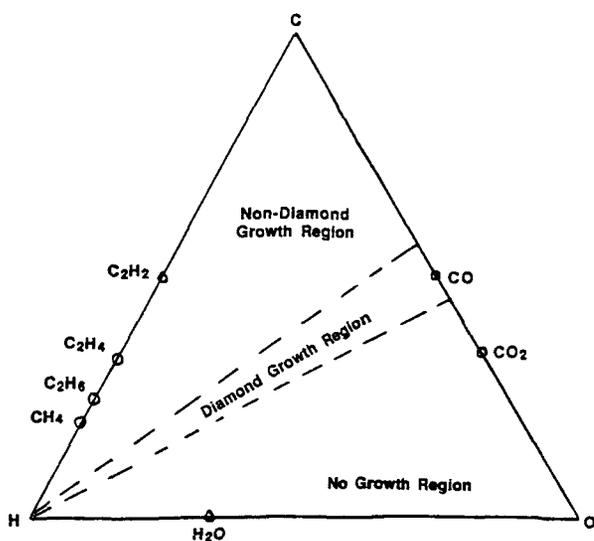

Figure 9a.

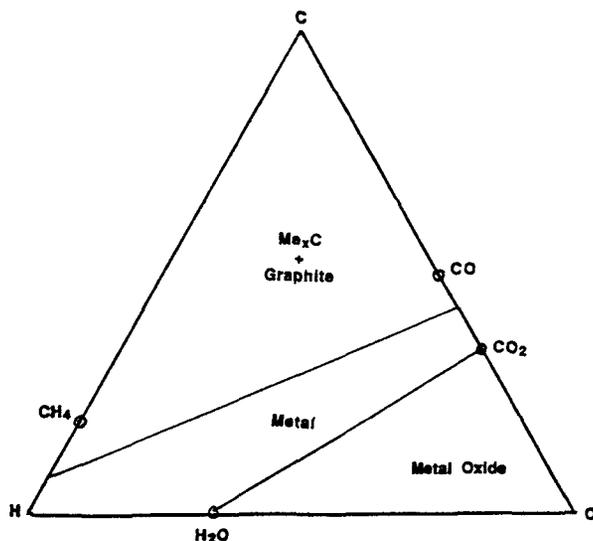

Figure 9b.

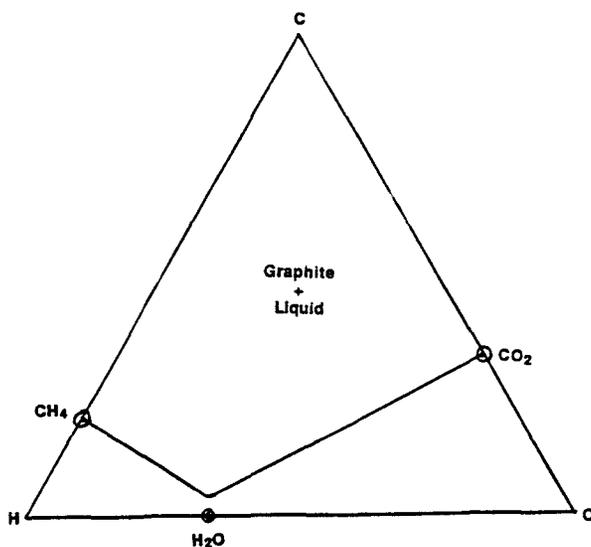

Figure 9c.

for growth of graphite filaments—but without atomic H. The Rumble C-H-O diagram (Fig. 9c) (also where H is H₂) defines the composition of liquids in equilibrium with graphite at 4 kbar and 600°C.⁹² Obviously 4 kbar is not enough, and the effect of atomic H in producing diamond is clear. The problem is that there is not an equivalent scavenger in the high pressure systems where graphite can form quite readily

along with diamond; atomic H is not stable under those conditions so there is not a continuous connection from the low to high pressure regimes. Perhaps in the Cheria/Patel system the molten salt also acts as both carbon transporter and etchant of graphite. Is there a graphite eliminator that can be effective in an intermediate pressure range? Some molten salts added in the synthesis of cubic BN synthesis do seem to drastically lower the nucleation temperature—and to a lesser extent the minimum pressure also.^{46,47}

Summary

C-H liquids are important as precursors determining the structure of carbon used in HPHT processes. The nature of this carbon when exposed to a metal at HPHT is a subject of controversy compounded by whether one believes in a metal as a dissolver of carbon or as a catalyst for the graphite to carbon conversion. The solution concept is the basis for design of metal systems for diamond synthesis. An interesting and recent possibility is the further lowering of Me-C eutectics by the addition of hydrogen. There is support for this concept in both CVD diamond and graphite synthesis. The system Me-C-H where atomic H is present is worth additional study. Most information on the P-T regime for diamond synthesis for both Me-C and C-H-O in the factory and in nature's laboratories do not support diamond formation below about 40 kbar and 1100°C. The unique role of atomic as a graphite suppressor/eliminator in low pressure CVD processes suggests a search for a higher pressure equivalent.

ACKNOWLEDGMENTS

R. Roy's research in this field supported by ONR and ARPA contracts. The collaborative interaction between the U.S. and Japan groups is funded by the Japanese Ministry of Education.

REFERENCES

1. Matsumoto, S., Setaka, N., Consolidation of diamond powders by thermal decomposition of methane and benzene, *J. Mater. Sci. Lett.*, **15**, 1222-36 (1980).
2. Matsumoto, S., Sato, Y., Tsutsumi, M., Setaka, N., Growth of diamond particles from methane-hydrogen gas, *J. Mater. Sci.* **17**, 3106-12 (1982).
3. Derjaguin, B.V., Spitsyn, B.V., et al., Synthesis of diamond crystals on nondiamond substrates, *Dokl. Akad. Nauk SSSR* **231**, 333-5 (1976).
4. Bundy, F.P., Hall, H.T., Strong, H.M., Wentorf, R.H., Jr., Man-made diamonds, *Nature* **176**, 51-54 (1955).
5. Yamada, S., A review of glass-like carbons, Battelle Memorial Institute, Defense Ceramic Information Center Report, 1968.
6. Noda, T., Inagaki, M., Yamada, S., Glass-like carbons, *J. Non-Crystalline Solids* **1**, 285-302 (1969).
7. Wentorf, R.H., Jr., Diamond synthesis, *Adv. in Chemical Physics* **IX**, 365-404 (1965)a.
8. Wentorf, R.H., Jr., The behavior of some carbonaceous materials at very high pressures and temperatures, *J. Phys. Chem.* **69**, 3063-69 (1965)b.
9. Laptev, V.A., Pomchalov, A., et al., Diamond crystallization characteristics in a system consisting of a metal and difficultly graphitizable carbonaceous substances, *Sverkhverd. Mater.* **1988** (4), 13-17.
10. Tsuzuki, A., Hirano, S., Naka, S., Effects of crystallinity of starting carbons on diamond formation in presence of nickel under high pressure and high temperature condition, *J. Mater. Sci.* **19**, 1153-8 (1984).
11. Vereshchagin, L.F., Kalashnikov, Ya. A., The mechanism of transformation of carbon-containing substances to diamond under static conditions, *High Temperatures-High Pressures* **Z**, 41-47 (1975).

12. Sekine, T., Akaishi, M., et al., Diamond synthesis by weak shock loading, *J. Mater. Sci.* 22, 3615-19 (1987).
13. Tovstogan, V.M., Lukash, V.A., et al., Phase composition, substructure, and thermal stability of diamonds obtained by dynamic methods, *Fiz. Tekh. Vys. Davlenii*, 2, 37-40 (1980).
14. Carli, P.S., Jamieson, J.C., Formation of diamond by explosive shock, *Science* 133, 1821 (1961).
15. Kertesz, M., Hoffmann, R., The graphite-to-diamond transformation, *J. Solid State Chem.*, 54, 313-19 (1984).
16. Leipunski, O.I., Synthetic diamonds, *Uspekhi Khimii* 8, 1519-1534 (1939).
17. Bundy, F.P., Bovenkerk, H.P., Strong, H.M., Wentorf, R.H., Jr., Diamond-graphite equilibrium line from growth and graphitization of diamond, *J.Chem.Phys.* 35, 383-91 (1961).
18. Bundy, F.P., Pressure-temperature phase diagrams of elemental carbon, *Physica A*, 156, 169-178 (1989).
19. Muncke, G., Physics of diamond growth, Chap. 15, pp. 473-499 in *The Properties of Diamond*, Edited by J.E.Field, Academic Press, London, 1979.
20. Wentorf, R.H., Jr., Solutions of carbon at high pressure, *Ber. Bunsengesellschaft fur physik Chemie* 70, 975-982 (1966).
21. Andreev, A.V., Role of the metal-graphite (diamond) interface in the mechanism of diamond synthesis, *Sverkhtverd. Mater.* 1988 (5), 5-9.
22. Shen, Z., Wang, L., et al., The formation mechanism of synthetic diamond at high pressure, *Physica B+C*, 139-140, 642-4 (1986).
23. Bokii, G.B., Volkov, A.I., Mode of formation of diamonds from graphite in the presence of metals, *Sov. Physics-Crystallog.* 14, 126-8 (1969).
24. Fedoseev, D.V., Kinetics of diamond nucleation in a colloidal solution of carbon in a metal, *Dokl. Akad. Nauk SSSR* 274, 910-12 (1984).
25. Varnin, V.P., Builov, L.L., Colloidal theory of the nucleation of diamond, *Zh. Fiz. Khim.* 64, 235-9 (1990).
26. Kaleshnikov, Ya. A., Shalimov, M.D., Nikol'skaya, I.V., Synthesis of diamond from glassy carbon, *Dokl. Akad. Nauk USSR* 219, 405-7 (1974).
27. Zhang, Y., Li, D., Role of solvent-catalyst on promotion of graphite to diamond transition, paper 07.7-01, A37 Suppl. 12th Intern. Congress of Crystallog., 8/15/1981.
28. Dymov, B.K., Bubnenkov, I.A., et al., Changes in carbon structure in the precrystallization stage of diamond synthesis, *Sverkhtverd. Mater.* 1983 (6), 9-13.
29. Arkhipov, R.G., Varfolomeeva, T.D., Popova, S.V., On the generation of nuclei and the mechanism governing the effects of metallic catalysts in the synthesis of artificial diamond, *Sov. Phys.-Dokl.* 16, 575:77 (1972).
30. Korolov, D.F., Butuzov, V.P., Bezurokov, G.N., Physicochemical characteristics of the formation of synthetic diamonds, *Fiz.-Khim. Probl. Kristalliz.* 1971 (2), 57-61.
31. Udoev, A.A., Kalashnikov, Ya.A., Svintitskikh, V.E., Structural aspect of catalytic diamond synthesis under high pressure and temperature conditions, *Sverkhtverd. Mater.* 1981 (3), 30-3.
32. Bezrukov, G.N., Butuzov, V.P., et al., Kinetic features of diamond crystallization, *Rost. Krist.* 1972 (9), 69-73.
33. Dymov, B.K., Kalshnikov, Ya.A., et al., Effect of nongraphitized phase of carbon on the synthesis and quality of diamond crystals, *Sverkhtverd. Mater.* 1991 (6), 3-6.
34. Elyutin, V.P., Polyakov, V.P., et al., Effect of amorphous carbon on the nucleation and growth of diamond crystals, *Dokl.Akad.Nauk SSSR* 297, 854-7 (1987).
35. Hirano, S., Shimono, K., Naka, S., Diamond formation from glassy carbon

- under high-pressure and temperature conditions, *J. Mater. Sci.* 17, 1856-62 (1982).
36. Gerlach, U., Vollstaedt, H., Fukunaga, O., et al., The influence of the nucleation behavior on the synthesis of diamond, AIRAPT 1989.
 37. Arkhipov, R.G., et al., On the initiation of nuclei and the mechanism of metallic catalyst action in the process of diamond synthesis, *Dokl. Akad. Nauk SSSR* 199, 55-57 (1971).
 38. Bundy, F.P., Diamond synthesis with non-conventional catalyst-solvents, *Nature* 241, 116-118 (1973).
 39. Strong, H.M., Catalytic effects in the transformation of graphite to diamond, *J. Chem. Phys.* 39, 2057 (1963).
 40. Akaishi, M., Kanda, H., Yamaoka, S., Synthesis of diamond from graphite-carbonate systems under very high temperature and pressure, *J. Cryst. Growth* 104, 578-81 (1990).
 41. Akaishi, M., Kanda, H., Yamaoka, S., High pressure synthesis of diamond in systems of graphite-sulfate and graphite-hydroxide, *Japan. J. Appl. Phys.*, 29, 75-77 (1990).
 42. Yamaoka, S., Akaishi, M., et al., Crystal growth of diamond in the system of carbon and water under very high pressure and temperature, *J. Cryst. Growth* 125, 375-7 (1992).
 43. Wakatsuki, M., New catalysts for synthesis of diamond, *Japan. Jour. Appl. Phys.* 5, 337 (1966).
 44. Gao, L., Nucleation of synthetic diamond, *Wuli Xuebao* 31, 1090-6 (1982).
 45. Fahy, S., Louie, S.G., Cohen, M.L., Pseudopotential total-energy study of the transition from rhombohedral graphite to diamond, *Phys. Rev. B Condens. Matter* 34, 1191-9 (1986).
 46. Solozhenko, V.L., Slutskii, A.B., Ignatiev, Yu.A., On the lowest pressure of sphalerite boron nitride spontaneous crystallization, *Sverkhtverdye Materialy* 14 (6), 61 (1992).
 47. Nakano, S., Ikawa, H., Fukunaga, O., Synthesis of cubic boron nitride by decomposition of magnesium boron nitride, *J. Am. Cer. Soc.*, 75, 240-3 (1992).
 48. Niedbalska, A., Szymanski, A., New concept of the diamond growth in the earth's crust, Proc of XXV Annual Meeting of the European High Pressure Research Group, Potsdam GDR, 8/25-27 (1987); High Pressure Geosciences and Materials Synthesis, Ed. H.Vollstadt; Akademie-Verlag, Berlin (1988).
 49. Niedbalska, A., Szymanski, A., Static diamond synthesis below 4 GPa, *Mater. Elektron.* 1989 (1), 23-9.
 50. Niedbalska, A., Szymanski, A., Manufacture of synthetic diamonds, *Pol. PL* 151,146; 8/31/1990; appl. 12/3/1987.
 51. Brannon, J.C., McCollum, S.L., Diamond formed at low pressures from ashed resin precursors, *New Diamond Sci. Technol.*, Proc. Int. Conf., 2nd, 1990. Ed. by R.Messier, Mater. Res. Soc., Pittsburgh, Pa., 1991.
 52. Gerlach, U., Risse, G., Wolf, E., Formation of diamond by chemical reactions at static pressure, *Sverkhtverd. Mater.*, 1988 (3), 21-3.
 53. Miyamoto, M., Akaishi, M., Ohsawa, T., et al., Morphology and formation process of diamond from glassy carbon, *J. Crystal. Growth* 97, 731-8 (1989).
 54. Oliveira, L.S.de C., Silva, M.T.X., et al., Mossbauer study of small amounts of iron in graphite, around the diamond-graphite pressure-temperature stability region, *Hyperfine Interactions* 66, 267-270 (1991).
 55. Polyakov, V.P., Elyutin, V.P., et al., Effect of hydrogen on polymorphic transformation of carbon in a metal-carbon melt under high pressure, *Dokl. Akad. Nauk SSSR* 307, 602-5 (1989).
 56. Tsuzuki, A., Hirano, S., Naka, S., Influencing factors for diamond formation from several starting carbons, *J. Mater. Science* 20, 2260-2264 (1985).
 57. Kulikova, L.F., Shalimov, M.D., et al., Synthesis of diamonds in graphite-metal

- hydride systems, *Sverkhtrverdye Materialy* 10, 3-4 (1988).
58. Chu, X., Gasification of graphite studied by scanning tunneling microscopy, *Carbon* 29, 1251-1255 (1991).
 59. Baker, R.T.K., Harris, P.S., In *Chemistry and Physics of Carbon*, Vol. 4, (Edited by P.L.Walker, P.L.Thrower), p.83. Marcel Dekker, New York 1978.
 60. Downs, W.B., Baker, R.T.K., Novel carbon fiber-carbon filament structures, *Carbon* 29, 1173-79 (1981).
 61. R. Roy, H.S. Dewan, and P. Ravindranathan, Crystallization of diamond below 1 atm from carbon-metal mixtures, *J. Mater. Chem.* 3(6), 685-686 (1993).
 62. R. Roy, H.S. Dewan and P. Ravindranathan, Diamond synthesis via a low-pressure solid-state-source process, *Mat. Res. Bull.*, 28(9), 861-866 (1993).
 63. Badzian, A., Badzian, T., Routes to diamond heteroepitaxy, *Chemical Vapor Deposition of Refractory Metals and Ceramics*, MRS Symp. Proc. 250 B, Edited by T.M. Beamann et al., MRS Pittsburgh, 1992.
 64. R. Roy, H.S. Dewan and P. Ravindranathan, Diamond synthesis via the low pressure solid state source (LPSS) process, Proc., 3rd Intl. Symp. Diamond Materials, Honolulu, HI, May 16-21 (1993).
 65. Yang, P.C., Zhu, W., Glass, J.T., Nucleation of oriented diamond films on nickel substrates, *J. Mater. Res.* 8, 1773-6 (1993).
 66. French, B.M., Some geological implications of equilibrium between graphite and a C-H-O gas phase at high temperatures and pressures, *Rev. of Geophysics* 4, 223-253 (1966).
 67. Frost, B.R., Mineral equilibria involving mixed-volatiles in a carbon-oxygen-hydrogen fluid phase: the stabilities of graphite and siderite, *Am. J. Sci.*, 279, 1033-59 (1979).
 68. Langford, R.E., The origin of diamonds. II. Theoretical study, *Taehan Hwahak Hoechi (J.Korean Chem. Soc.)* 22, 138-49 (1978).
 69. Berman, R., Simon, F., On the graphite-diamond equilibrium, *Z. fur Elektrochemie Ber. der Bunsengesellschaft fur Physik Chim.*, 59, 333-338 (1955).
 70. Kennedy, G.C., Nordlie, B.E., The genesis of diamond deposits, *Econ. Geol.* 63, 495-503 (1968).
 71. Ryabchikov, I.D., Nature of kimberlite "magmas," *Geol. Rudn. Mestorozhd.* 22, 18-26 (1980).
 72. Marakushev, A.A., Problem of the fluid regime in the formation of diamond-bearing rocks, *Geol. Rudn. Mestorozhd.* 23, 3-17 (1981).
 73. Simakov, K., Formation and crystallization of diamond from fluid in mantle melts, *Dokl. Akad. Nauk SSSR* 266, 470-3 (1982).
 74. Eggler, D.H., Baker, D.R., Reduced volatiles in the system C-O-H: Implications to mantle melting, fluid formation, and diamond genesis, *Adv. in Earth and Planetary Sciences 12, High Pressure Research in Geophysics*, Eds. S. Akimoto, M.H. Manghnani, pp 237-250; Center for Academic Publications, Japan/Tokyo (1982).
 75. Piekarczyk, W., unpublished.
 76. Boyd, F.R., Pearson, G., Nixon, P., Graphite-bearing mantle xenoliths from the Kaapvaal Craton: Implications for graphite and diamond genesis, *Carnegie Institution of Washington, Year Book* 89, 84-86.
 77. Fedorov, I.I., et al., The experimental and thermodynamic modeling C-O-H fluid in equilibrium with graphite and diamond in the high PT parameter range, *Dokl. Akad. Nauk SSSR* 320, 710-12 (1991).
 78. Haggerty, S.E., Diamond genesis in a multiply-constrained model, *Nature* 320, 34-43 (1986).

79. Taylor, W.R., Green, D.H., Measurement of reduced peridotite-C-O-H solidus and implication for redox melting of mantle, *Nature* 332, 349-52 (1988).
80. Ulmer, P., Luth, R.W., The graphite-COH fluid equilibrium in P, T, and fO_2 space. An experimental determination to 30 kbar and 1600 degree C, *Contrib. Mineral. Petrol.* 106, 265-72 (1991).
81. Fei, Y., Mysen, B.O., Mao, H.K., Experimental determination of the fO_2 of the graphite/diamond-COH fluid buffer up to a pressure of 15 GPa, Annual Report Director Geophysical Lab., Washington, 1990, pp 54-58; also Paper M52A-14 1645 H, p. 619 in *Trans. Am. Geophys. Union* 71 (17), 4/24/90.
82. Ryabchikov, I.D., Carbon compounds under the condition of the upper mantle, *Geochimya* 11, 1539-46 (1988).
83. Jakobsson, S., Oskarsson, N., Experimental determination of fluid compositions in the system carbon-oxygen-hydrogen at high P and T and low fO_2 , *Geochim. Cosmochim Acta* 54 355-62 (1990).
84. Dunn, J.R., Fisher, D.W., Occurrence, properties and paragenesis of anthraxolite in the Mohawk Valley, *Am. J. Sci.*, 252, 489-501 (1954).
85. Karwowski, L., Dorda, J., The mineral-forming environment of "Marmaros Diamonds," *Mineralogia Polonica* 17, 3-11 (1986).
86. Kisch, H.J., Van den Kerkhof, A.M., CH_4 - CO_2 inclusions from quartz veins in the Valley-and-Ridge province and the anthracite fields of the Pennsylvania Appalachians, *Am. Min.* 76, 230-240 (1991).
87. Jedwab, J., Boulegue, J., Graphite crystals in hydrothermal vents, *Nature* 310, 41-43 (1984).
88. Pasteris, J.D., Occurrence of graphite in serpentinized olivines in kimberlite, *Geology* 9, 356-9 (1981).
89. Katz, M.B., Graphite deposits of Sri Lanka: a consequence of granulite facies metamorphism, *Mineralium Deposita* 22, 18-25 (1987).
90. Kornprobst, J., Pineau, F., Primary igneous graphite in ultramafic xenoliths: I. Petrology of the cumulate suite in alkali basalt near Tissemt (Eggere, Algerian Sahara), *J.Petrol.* 28, 293-311 (1987).
91. Rumble III, D., Duke, E.F., Hoering, T.L., Hydrothermal graphite in N.H.: Evidence of carbon mobility during regional metamorphism, *Geol.* 14, 452-55 (1986).
92. Rumble III, D., Hoering, T.L., Carbon isotope geochemistry of graphite vein deposits from New Hampshire, USA, *Geochem. Cosmochim Acta* 50, 1239-47 (1986).
93. Melton, C.E., Salotti, C.A., Giardini, A.A., The observation of nitrogen, water, carbon dioxide, methane and argon as impurities in natural diamonds, *Amer. Min.* 57, 1518-1523 (1972).
94. Melton, C.E., Giardini, A.A., Composition and significance of gas released from natural diamonds from Africa and Brazil, *Amer. Mineral.* 59, 775-82 (1974).
95. Giardini, A.A., Melton, C.E., Gases released from natural and synthetic diamonds by crushing under high vacuum at 200 C, and their significance to diamond genesis, *Fortshr. Min.* 52, 455-464 (1975).
96. Bratus, M.D., Svoren, I.M., et al., Gas components of inclusions in diamonds of diverse morphological types from Yakutia, *Geokhimiya* 1991 (11), 1586-95 (1991).
97. Chrenko, R.M., McDonald, R.S., Infra-red spectra of diamond coat, *Nature* Feb. 4, 1967; 474-476.
98. Boyd, S.R., Pillinger, C.T., et al. Carbon and nitrogen isotopic composition and the infrared absorption spectra of coated diamonds: evidence for the regional uniformity of carbon dioxide-water rich fluids in lithospheric mantle, *Earth Planet. Sci. Lett.* 108, 139-50 (1992).

99. Navon, O., Hutcheon, I.D., Mantle-derived fluids in diamond micro-inclusions, *Nature* 335, 784-9 (1988).
100. Navon, O., High internal pressures in diamond fluid inclusions determined by infrared absorption, *Nature* 353, 746-8 (1991).
101. Turner, G., Burgess, R., Bannon, M., Volatile-rich mantle fluids inferred from inclusions in diamond and mantle xenoliths, *Nature* 344, 653-5 (1990).
102. Guthrie, G.D., Veblen, D.R., et al., Submicrometer fluid inclusions in turbid-diamond coats, *Earth Planet. Sci. Lett.* 105, 1-12 (1991).
103. Richardson, S.H., Gurney, J.J., et al., Origin of diamonds in an old enriched mantle, *Nature* 310, 198-202 (1984).
104. Watson, E.B., Brenan, J.M., Fluids in the lithosphere, 1. Experimentally-determined wetting characteristics of CO₂-H₂O fluids and their implications for fluid transport, host-rock properties, and fluid inclusion formation, *Earth and Planetary Science Letters* 85, 497-515 (1987).
105. Shatskii, V.S., Sobolev, N.V., et al., New manifestation of micro-diamonds in metamorphic rocks as an evidence of the regional character of high-pressure metamorphism in the Kokchetav Massif, *Dokl. Akad. Nauk SSSR* 321, 189-93 (1991).
106. Sobolev, N.V., Shatskii, V.S., Carbon mineral inclusions in garnets of metamorphic rocks, *Geol. Geofiz.* 1987 (7), 77-80.
107. Sobolev, N.V., Shatskii, V.S., Diamond inclusions in garnets from metamorphic rocks: a new environment for diamond formation, *Nature* 343, 742-45 (1990).
108. Xu, S., Okay, A.I., et al., Diamond from the Dabie Shan metamorphic rocks and its implication for tectonic setting, *Science* 256, 80-2 (1992).
109. Lavrova, L.D., A new type of diamond deposits, *Priroda* 1991 (12), 62-8.
110. Rudenko, A.P., Kulakova, I.I., Kimberlite diamond formation conditions and the theory of open catalytic systems, *Geochemistry International* 27, 42-51 (1990).
111. Chepurov, A.I., Sonin, V.M., Crystallization of carbon in silicate and metal-silicate systems at high pressures, *Geol. Geofiz.* 1987 (10), 78-83.
112. Kadik, A.A., Shilobreeva, S.N., The solubility of carbon and carbon dioxide in the magmatic melts and crystals under high pressure and temperature, *High Pressure Geoscience and Materials Systems, Proc. XXV Annual Mtg. European High Pressure Group*, 8, 25-27 (1987).
113. Mathez, E.A., Blacic, J.D., et al., Carbon in olivine: Results from nuclear reaction analysis, *J. Geophys. Res., B*, 92(B5), 3500-6 (1987).
114. Tingle, T.N., Green, H.W., Finnerty, A.A., Experiments and observations bearing on the solubility and diffusivity of carbon in olivine, *J. Geophys. Res., Solid Earth Planets* 93(B12), 15289-304 (1988).
115. Nestor, L.R., Glass containing dissolved carbon, U.S. Patent 3,348,917; Oct. 24, 1967; appl. July 22, 1960.
116. Freund, F., Wengeler, H., The infrared spectrum of hydroxide-compensated defect sites in carbon-doped magnesium oxide and calcium oxide single crystals, *J. Phys. Chem. solids* 43, 129-45 (1982).
117. Freund, F., Wengeler, H., et al., Hydrogen and carbon derived from dissolved H₂O and CO₂ in minerals and melt, *Bull. de mineralogie*, 106, 185 (1983).
118. Freund, Presence, segregation and reactivity of hydrogen, carbon, and nitrogen dissolved in some refractory oxides, *J. Phys. Colloq.* 1986 (C1), C1-499-C1508.
119. Eggler, D.H., The effect of CO₂ upon partial melting of peridotite in the system Na₂O-CaO-Al₂O₃-MgO-SiO₂-CO₂ to 35 kb, with an analysis of melting in a peridotite-H₂O-CO₂ system, *Am. J. Sci.*, 278, 305-343 (1978).

120. Eggler, D.H., Mysen, B.O., et al., The solubility of carbon monoxide in silicate melts at high pressures and its effect on silicate phase relations, *Earth Planet. Sci. Lett.* **43**, 321-30 (1979).
121. Boettcher, A.L., The system silica-water-carbon dioxide: melting, solubility mechanisms of carbon, and liquid structure to high pressures, *Am. Mineral.* **69**, 823-33 (1984).
122. Mysen, B.O., Virgo, D., Solubility mechanisms of water in silicate melts at high pressures and temperatures: a Raman spectroscopic study: reply, *Am. Mineral.* **67**, 155 (1982).
123. Ellis, D.E., Wyllie, P.J., Carbonation, hydration, and melting relations in the system magnesium oxide-water-carbon dioxide at pressures up to 100 kbar, *Am. Mineral.* **64**, 32-40 (1979).
124. Wyllie, P.J., Huang, W.L., et al., Carbonation of peridotites and decarbonation of siliceous dolomites represented in the system calcium oxide-magnesium oxide-silicon dioxide-carbon dioxide to 30 kbar, *Tectonophysics* **100**, 359-88 (1984).
125. Taylor, W.R., The dissolution mechanism of carbon dioxide in aluminosilicate metls. Infrared spectroscopic constraints on the cationic environment of dissolved $[\text{CO}_3]_2$, *Eur. J. Mineral* **2**, 547-63 (1990).
126. Chepurov, A.I., Role of sulfide melt in the formation of diamond in nature, *Geol. Geofiz.*, **1988** (8), 119-24.
127. Efimova, E.S., Sobolev, N.V., Pospelova, L.N., Sulfide inclusions in diamonds and characteristics of their paragenesis, *Zap. Vses. Mineral. O-va.*, **112**, 300-10 (1983).
128. Langford, R.E., Melton, C.E., Giardini, A.A., Diamond growth by sulfide reduction of carbon dioxide, *Nature* **249**, 647 (1974).
129. Marx, P.C., Pyrrhotine and the origin of terrestrial diamonds, *Min. Mag.* **38**, 636-8 (1972).
130. Spetsius, Z.V., Bulanova, G.P., First find of sulfides in contact with diamonds in eclogite xenoliths of the Udachnaya pipe, *Dokl. Akad. Nauk SSSR*, **306**, 176-80 (1989).
131. Kadik, A.A., Redox state of the upper mantle, *Proc. Indian Acad. Sci., Earth Planet. Sci.*, **99**, 141-52 (1990).
132. Eggler, D.H., Upper mantle oxidation state: evidence from olivine-orthopyroxene-ilmenite assemblages, *Geophys. Res. Lett.*, **10**, 365-8 (1983).
133. Daniels, L.R.M., Gurney, J.J., Oxygen fugacity constraints on the southern African lithosphere, *Contrib. Mineral. Petrol.* **108**, 154-61 (1991).
134. Sobolev, N.V., Efimova, E.S., Pospelova, L.N., Native iron in diamonds of Yakutia and its paragenesis, *Geologiya i Geofizika* **22**, 25-28 (1981).
135. French, B.M., Rosenberg, P.E., Siderite (FeCO_3) thermal decomposition in equilibrium with graphite, *Science* **141**, 1283-4 (1965).
136. Woermann, E., Diamonds, *Ger. Offen.* 2,721,644; 11/23/78; appl., 5/13/77.
137. Patel, A.R., Cherian, K.A., Overgrowths on diamond at atmospheric pressure, *J. Cryst. Growth* **46**, 706-708 (1979).
138. Patel, A.R., Cherian, K.A., Crystallization of diamond at atmospheric pressure, *Indian Journal of Pure and Applied Physics* **19**, 803-820 (1981).
139. Patel, A.R., Cherian, K.A., On the possible origins of natural diamonds, *Pramana* **22**, 377-86 (1984).
140. Cherian, K.A., Metastable surface recrystallization of diamond from the liquid phase: substrate effects, *Mater. Sci. Monogr.* **1991**, **73** (Appl. Diamond Films Relat. Mater.) 389-94 .
141. Cherian, K.A., Nickel-assisted metastable diamond formation (surface recrystallization in a dissolution medium at atmospheric pressure, *Surf. Coat. Technol.* **47**, 127-43 (1991).
142. French, E.A., French, D.A., Ultra-hard particles of carbon produced by reacting

- metal carbide with non-metal halide in hot melt system, U.S. 4,352,787; 6/22/81.
143. Gerlach, U., Hennig, H., et al., Manufacture of high-pressure-modified carbon, especially diamond or diamond-like carbon, Ger. (East) DD 257,375; 6/15/88; appl., 12/2/83.
 144. Bachmann, P.K., Leers, D., Lydtin, H., Toward a general concept of diamond chemical vapor deposition, *Diamond and Related Materials* 1, 1-12 (1991).
 145. Jablonski, G.A., Geurts, F.W., et al., Carbon deposition over Fe, Ni, and Co foils from CO-H₂-CH₄, CO₂-H₂O, CO-CO₂, CH₄-H₂, and CO-H₂-H₂O gas mixtures: I. Morphology, *Carbon* 30, 87-98 (1992); II. Kinetics, *Carbon* 30, 99-106 (1992).

APPENDIX 1

Evaluation of the possibility of diamond crystal growth under hydrothermal conditions*

Dr. Wladyslaw Piekarczyk
Materials Research Laboratory
The Pennsylvania State University
University Park, PA 16802

1. Composition of the gas phase

The composition of the gas phase was calculated with the help of the SOLGASMIX program by G. Eriksson. Thirty gaseous species were taken into consideration in introductory calculations. Afterwards, species whose partial pressures were lower than 10^{-3} atm in the entire pressure and temperature ranges were omitted and only 14 gaseous species remained in the system. Graphite and water were the starting materials. Calculations were performed for total pressures of 5000 and 10000 atm and temperatures from 700 to 1300 K. The following simplifying assumptions were accepted:

1. Solid carbon (graphite) is always present in the system.
2. Gases behave as ideal ones. Consequently, no activity corrections were made.

It should be stressed here, however, that water (and some other compounds present in the system) can exist in the critical state only under the given conditions.

The calculation results is displayed in Table 2 (see main text). The main constituents of the gas phase are H_2O , CH_4 , CO_2 , CO and H_2 .

2. Solubility of carbon in water under hydrothermal conditions

The solubility of carbon in the gas phase, expressed in atomic fractions, under the considered conditions is shown in Figure 1. As seen from the figure the solubility is fairly high (~15%), slightly increases with temperature

and practically does not depend on total pressure. For this reason small growth rates (typical for the hydrothermal method) can be expected even at possibly large temperature differences between the dissolution and growth zones.

3. Concentration of double carbon-carbon bonds formed on surfaces of growing diamond crystal

The approximate ratio of the number of single carbon-carbon bonds, $n(sp^3)$, to the number of double carbon-carbon bonds, $n(sp^2)$, formed on surfaces of diamond crystals during their growth under the considered conditions are given in Table 2 (see main text). These ratios were calculated using equilibrium constants of reaction (7) in ref. [1]

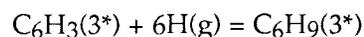

and the equilibrium partial pressures of atomic hydrogen, $P(H)$, given in Tables I and II. "Benzene-like," $C_6H_3(3^*)$, and "cyclohexane-like," $C_6H_9(3^*)$, clusters play a crucial part in the growth process of diamond on {111} faces [1]. The standard Gibbs energy of the above reaction can be estimated with the help of the equation

$$\begin{aligned} \Delta G^\circ [\text{cal}] = & -408782 + 50.076 \cdot T \\ & + 21.649 \cdot T \ln T - 16.858 \cdot 10^{-3} \cdot T \\ & + 15.083 \cdot 10^5 / T + 1.649 \cdot 10^{-6} \cdot T^3 \end{aligned}$$

As seen from Table I the ratio $n(sp^3)/n(sp^2)$ assumes values higher than 10^3 at temperatures lower than around 1100 K which means that at these temperatures the equilibrium partial pressures of atomic hydrogen are sufficiently high to suppress the formation of double bonds. At higher temperatures a considerable number of double bonds could be formed. Hence, one can expect that diamond crystals free of graphite (or other non-diamond carbon form) inclusions can grow at least in the lower temperature range, especially at the higher total pressure.

* This paper was presented at the DRMC meeting in the Fall of 1990.

4. General conclusion

It results from the above considerations that diamond crystals should grow, albeit slowly, under hydrothermal conditions. In order to avoid graphite codeposition the growth temperature should be in the lower temperature range but the total pressure should be as high as feasible.

References

- [1] W. Pickarczyk, Diamond-Vapor Interface and Processes Proceeding on It During Growth of Diamond Crystals, I. Diamond (111) Face, submitted to *J. Crystal Growth*.

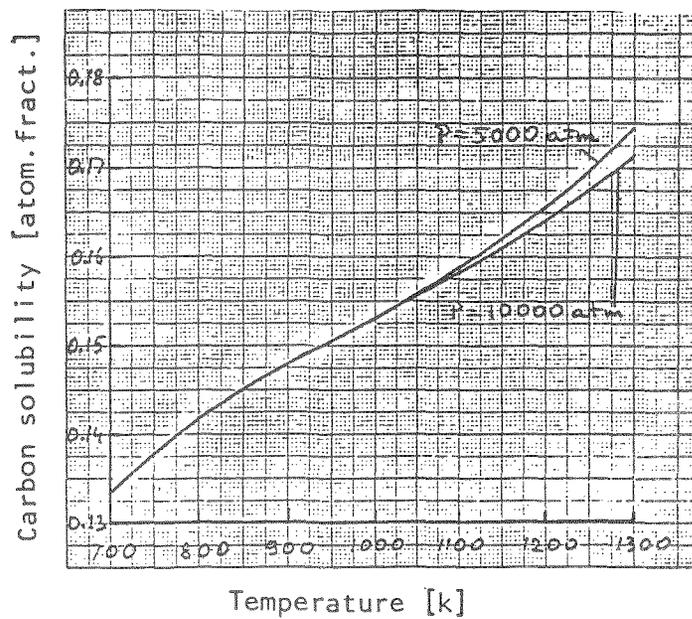

Figure 1

Ph.D. from Pennsylvania State University, State College, Pa. in
Geochemistry/Mineralogy, 1953
Postdoctoral Fellow at Penn State, 1953-54
Staff Scientist, General Electric Research Laboratory, Schenectady,
N.Y., 1954-1961
Associate Professor in Materials Science and Engineering Department,
Rensselaer Polytechnic Institute, Troy, N.Y., 1961-1965
Staff Scientist, General Electric Corporate R and D Center,
Schenectady, N.Y., 1965-1988
Consultant, 1988-

Professional Interests

Synthesis and properties of ceramic materials and relationships of
both crystal structure and microstructure to properties. Crystal
chemistry. Phase equilibria of inorganic, non-metallic systems at
both high and low pressure conditions. Crystal growth. Synthesis of
diamond and cubic BN under both high and low pressure (CVD)
conditions. Origin of natural diamond. Characterization of
synthesized and natural diamond. Gemology.

Publications and Patents

83 papers, 25 patents, one edited book

Awards

Rector Scholar, DePauw University
ASM Engineering Materials Achievement Award, 1973
Cultural Exchange Visitor, Japan, 1974
Fellow of the American Ceramic Society
Fellow of the American Mineralogical Society
Coolidge Fellow, GE R and D Center, 1981

